

PERFORMANCE ANALYSIS OF A MULTIJUNCTION SOLAR CELL OPERATING UNDER NATURAL CONDITIONS AND VARIOUS CONCENTRATION RATES

H. M. da Silva^{1,2}, O.C. Vilela¹, and N. Fraidenraich¹

¹Federal University of Pernambuco, Nuclear Energy Dept., Recife (Brazil)

²Pernambuco Institute of Technology, ITEP Recife (Brazil)

RESUMEN: El desempeño de una celda fotovoltaica multiunión con $1,0 \text{ cm}^2$ es evaluado para varias tasas de concentración. Parámetros que caracterizan la celda son extraídos de curvas características obtenidas experimentalmente con base en el modelo de un diodo. Especial atención es dedicada a resistencia serie de la celda. Resultados demuestran que el procedimiento es consistente, permitiendo obtener una visión general del comportamiento de las celdas multiunión, a pesar de grandes variaciones experimentales de temperatura y radiación. Se observa una alta resistencia serie ($3,8 \Omega$) para baja concentración. Esta resistencia disminuye, alcanzando un valor estable para altas concentraciones ($0,024 \Omega$). Se han medido eficiencias promedio de conversión del 35% cuando se convierte la temperatura de referencia. La resistencia serie obtenida para altas concentraciones limita el índice de concentración que corresponde a máxima eficiencia entre 243 y 278. Mayores índices de concentración y probablemente eficiencias superiores requieren mayor reducción de la resistencia serie.

Palabras-clave: celdas solares multiunión, eficiencia, análisis de parámetros.

INTRODUCTION

During the last two decades, multijunction (MJ) solar cells, associated with solar radiation concentrator systems for terrestrial applications or without concentration for space applications, have been able to improve considerably the efficiency of photovoltaic converters. The finding that high efficiency values are tangible in practice has encouraged the development of both research and commercial interest for such devices (King, 2007). To ensure the conditions necessary to control the tests and repeat the results, the experiments are usually held in laboratories equipped with artificial sources of radiation. That is so, e.g., for the determination of the cell efficiency from the characteristic curve (current versus voltage) obtained under certain conditions of irradiance (absolute value and spectral distribution) and temperature (Dominguez, 2010).

Several methods, analytic or algebraic, have been developed and applied in the analysis of the operational characteristics of PV solar cells. Algebraic methods employ simple equations to correct the characteristic curve (I-V) for temperature and irradiance (Shockley, 1961 & Campbell, 1986), while the physics of semiconductors admits analytical methods to describe the effects of moderate variations in those parameters (Emery, 2003). Considering the phenomena of diffusion and recombination of charge carriers in the neutral and space charge regions of the cell, responsible for the diode current (I_D), the two diodes model yields the most detailed evaluation of the parameters describing (I-V) curve. However, since recombination dominates at low voltages, where photovoltaic devices do not work often, one diode model can be satisfactory (Garcia, 1995).

Since 1999 when MJ solar cells with three junctions and two terminals have begun to be used, efficiency records have been established successively. The last and important ones are: In 2005, a cell formed by $\text{In}_{0.495}\text{Ga}_{0.505}\text{P}/\text{In}_{0.01}\text{Ga}_{0.99}\text{As}/\text{Ge}$ developed by Spectrolab, a leading manufacturer of high performance cells, reached an efficiency of 39.0%, employing an AM1.5G spectrum and concentration ratio of 236 suns (King, 2005). Later, in 2007, the same cell with different percentage components $\text{In}_{0.56}\text{Ga}_{0.44}\text{P}/\text{In}_{0.08}\text{Ga}_{0.92}\text{As}/\text{Ge}$, reached 40.7%, with AM1.5D spectrum and under concentration of 240 suns (King, 2007). In 2009, the Fraunhofer Institute in Germany increased the concentration of indium to form the structure $\text{In}_{0.65}\text{Ga}_{0.35}\text{P}/\text{In}_{0.17}\text{Ga}_{0.83}\text{As}/\text{Ge}$, obtaining an efficiency of 41.1% under 454 Suns and AM1.5D spectrum (Guter, 2009). In 2010 Spire Semiconductor, a Spire Corporation subsidiary, with a cell of 0.97 cm^2 under AM1.5D spectrum and concentration of 406 suns, reached 42.4% (NREL, 2010). Currently, the maximum conversion efficiency was established at 43.5% by a cell with 0.3124 cm^2 , under 418 suns (Green, 2011).

In this paper we evaluate the performance of a CPV multijunction (MJ) cell ($\text{InGaP}/\text{InGaAs}/\text{Ge}$) of 1.0 cm^2 area, for concentration ratios varying from one up to one hundred and fifty times approximately. The efficiency of concentrating PV cells is usually expressed as a function of incident radiation through the concentration rate (C) and, according to the model adopted, its greatness depends on the following parameters: photo generated current (I_L), saturation diode current (I_0), ideality factor (m), parallel resistance (R_p) and series resistance (R_s). Special attention was given to series resistance downward trend as shown by different methods which effects can change significantly the cell performance (Daliento and Lancellotti, 2010).

Different procedures are available to extract these parameters from the characteristic curve (CC) of the cell and, as commented before, they are usually obtained indoor, under controlled conditions of irradiance and temperature. However,

outdoor tests provide relevant information that can be used to determine the real operational behavior of the cell (Tanabe, 2009). In this work the model parameters are extracted from the experimental curves and special attention is given to the series resistance which effects can modify significantly the cell performance will be shown.

EXPERIMENTAL METHODOLOGY

The MJ solar cell used on experiments is a three junction InGaP/InGaAs/Ge structure with approximately 1.0 cm² area. At 500 suns and 25°C in indoors experiments, the efficiency is about 37%, according to manufacturer's information.

The cell has been evaluated operating under natural conditions of irradiance on two different outdoor tests. Initially, without concentration (one sun), with the cell placed on a horizontal plane inside a box with glass cover, and then, with concentration, using a Fresnel lens system mounted on a two-axis tracker. In the first case the cell is under the influence of direct and diffuse irradiance, and in the second case, only direct irradiance reaches the cell.

For the experiments it was set up an electric circuit composed of the MJ cell, responsible for current generation, a potentiometer for simulating a variable charge and a calibrated shunt to measure the current. Measurements of global and direct irradiance, were performed using three pyranometers (two photovoltaic and one thermal) and a pyrheliometer. The temperature of the cell was measured using a sensor (LM35) coupled to a structure with high electric and thermal conductivity on which the cell was set up. All sensors were connected to a Campbell data acquisition system model CR10X (data logger). The voltage of the cell is directly assessed in one channel of the data logger.

Figures 1a shows the facility for the tests performed at one sun. The irradiance incident on the cell plane is evaluated using the PV pyranometer inside the box. The photovoltaic pyranometer outside the box allows evaluating the glass attenuation for the solar irradiance and the thermal pyranometer gives an appraisal of the quality of the PV measurements. Figure 1b shows the cell inside the structure used to perform the tests under concentration.

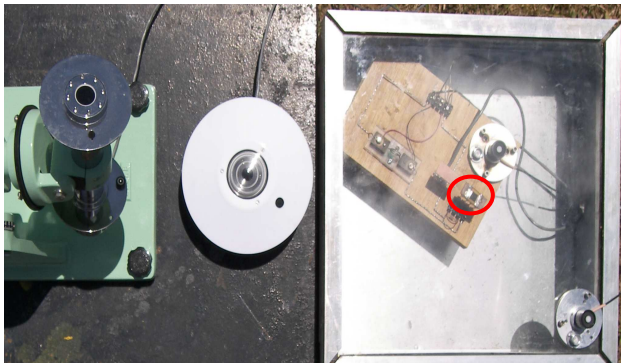

Figure 1a: Initial assembly

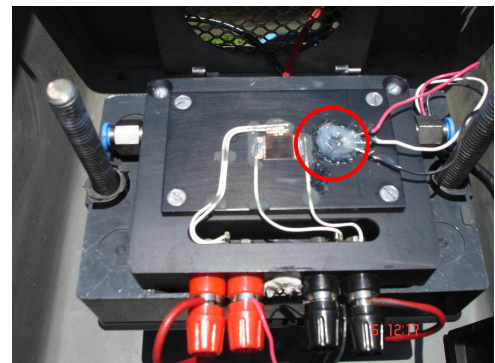

Figure 1b: Assembly in heat sink

The experimental device for characterizing the cell with concentration uses a square Fresnel lens with side 0.30m and focal length 0.20m. A pair of screws fixed at the bottom of a metal box allows the adjustment of the position of the solar cell (up and down movement). The position of the cell with respect to the lens defines different concentration rates of operation. This set was placed on a high-precision (0.1°) two-axis tracker in order to collect direct irradiance. Figure 2a shows the experimental device placed on the tracker (preparation of the rig test) and Figure 2b shows the cell under concentration during experiments.

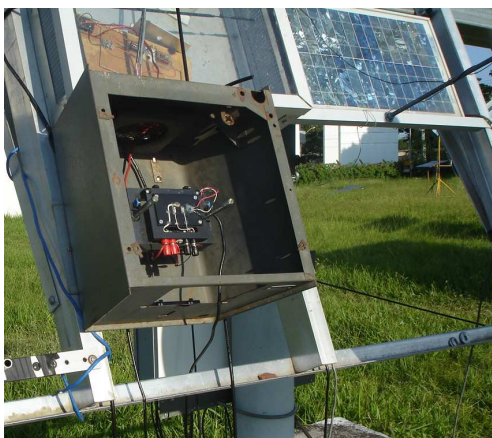

Figure 2a: Preparation of the rig test.

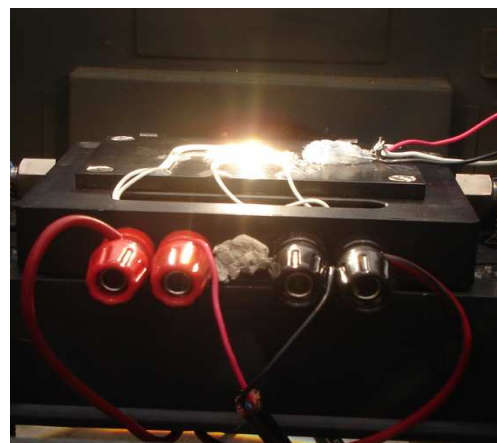

Figure 2b: Cell under concentration.

After preparing the tests, the characteristic curves of the cell are obtained by varying the potentiometer resistance. In addition to the experiments for obtaining the (I-V) curves, it has been measured short-circuit current (I_{sc}) and open circuit voltage (V_{oc}) for different values of cell temperature. In order to be able to consider the influence of irradiance exclusively, an indoor

experiment using an artificial light source (Hg -Xe lamp) was performed to analyze the variations of (V_{oc}) and (I_{sc}) with temperature.

The level of effective irradiance on the MJ cell during the tests with concentration was estimated considering that the relationship of short-circuit current and incident irradiance is linear. This assumption is not strictly correct; however, devices with high performance tend towards linear behavior (Sanchez and Araújo, 1984).

Thus, defining a standard (I-V) curve from the tests performed at one sun, we obtain, for the cell under concentration, the concentration rate as follows

$$C = \frac{I_{sc,conc}}{I_{sc,1sun}} \quad (1)$$

where $I_{sc,conc}$ is the short-circuit current measured under concentration and $I_{sc,1sun}$ is the short-circuit current measured for the one-sun standard (I-V) curve. This is a simple way to determine the concentration ratio, considering only the radiation incident on the cell. A more detailed treatment should take into account the effects of spectral radiation and temperature (Dominguez, 2010).

MJ SOLAR CELL CHARACTERISTIC PARAMETERS

One diode model can be described by the electrical circuit shown in Figure 3.

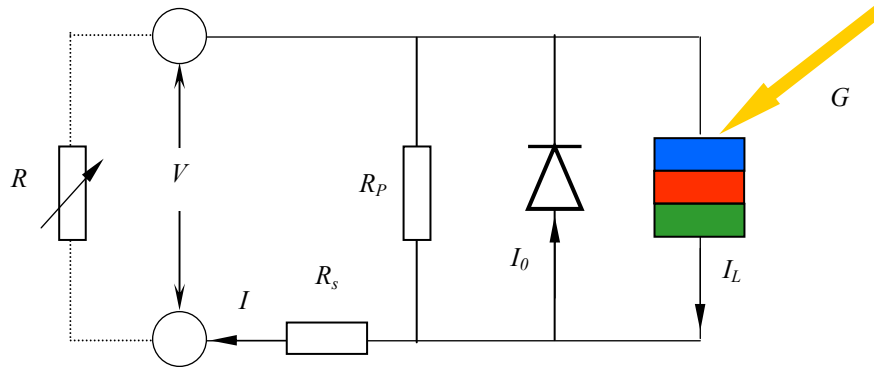

Figure 3: Electrical circuit of one diode model

The electric current (I) established in circuit as function of voltage (V), under the effect of irradiance (G) incident on cell, operating at a given temperature value (T) is described by Eq. 2.

$$I = I_L - I_0 \left\{ \exp \left[\frac{V + R_s I}{m v_t} \right] - 1 \right\} - (V + R_s I) / R_p \quad (2)$$

where I_L is the light-generated current, I_0 the diode saturation current, m the ideality factor of the diode, R_s and R_p are the series and parallel resistance of the cell respectively and v_t is the thermal voltage, which relates the cell temperature T with the electronic charge q by the Boltzmann constant k ($v = kT/q$).

The MJ solar cell tested that belongs high quality, we have considered that the parallel resistance R_p is large enough such that the third term of Eq. 2 can be neglected. It is also assumed that the light-generated current can be approximated by the short-circuit current $I_L \approx I_{sc}$ (Green, 1982). Therefore, Eq. 2, after approximations, can be rewritten as

$$I = I_{sc} - I_0 \left\{ \exp \left[\frac{V + R_s I}{m v_t} \right] - 1 \right\} \quad (3)$$

This model were used to compare experimental results to expected values from characteristics curves on both situations: at one sun and under concentration. From Equation 3, the diode saturation current can be obtained on the open circuit condition as

$$I_0 = I_{sc} / \left\{ \exp \left[\frac{V + R_s I}{m v_t} \right] - 1 \right\} \quad (4)$$

In order to evaluate the diode ideality factor (m) of the cell, we consider the logarithmic dependence of the open circuit voltage (V_{oc}) with the solar irradiance - or, with concentration rate (C), written as

$$V_{oc}(C) = V_{oc,1sun} + m v_t \ln(C) \quad (5)$$

where $V_{oc,1sun}$ is the open circuit voltage at one sun condition (taken from the one sun standard characteristic curve) and $V_{oc}(C)$ is the open circuit voltage for a given concentration rate. It should be noted that the effective ideality factor is given by the sum of ideality factor of each junction, according to the value shown by Katz (2006) and applied methodology by Dominguez (2010). This means that the MJ cell was assessed as it were a single solar cell.

A plot of experimental values of V_{oc} as a function of $\ln(C)$ results in a straight line with slope equal to the product mv_i . The parameters R_s and I_0 can be extracted by different methods (Ortiz-Conde, 2006). In this paper we use the optimization method where the characteristic curves obtained experimentally are directly fitted to (eq. 3) - one diode model.

RESULTS AND ANALYSIS

One sun experiments

According to present proposal, first experiments were devoted to characterize the MJ cell functioning without concentration. Thus, short circuit current, open circuit voltage and operating temperature behaviors were observed for several values of irradiance incident on the cell aperture. Figure 4 shows these behaviors for irradiance range between 200W/m² and 1200W/m², approximately.

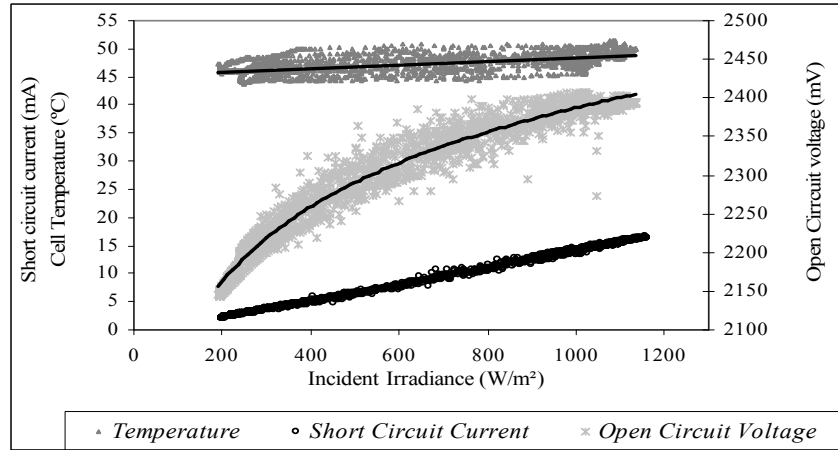

Figure 4: Temperature, short circuit current and open circuit voltage behavior versus incident irradiance.

Temperature of the cell observed in this experiment varies in range of 43.8 °C to 51.5 °C for irradiance going from 192 W/m² to 1135 W/m². The gradient of temperature is around 0.003°C/Wm⁻². At one sun condition (1000 W/m²) cell temperature is 47.0 ±1.3 °C. For the same range of temperature it is shown in Figure 4 the logarithmic trend of open circuit voltage with irradiance, with minimum value of 2.15V and maximum around 2.4 V. As expected, in this range, the short circuit current presents a clear linear behavior with solar irradiance, with small root mean square deviation of the order of 2.8%. For the standard condition of one sun, we find values of short-current density around 14.1 ± 0.3 mA/cm² and open circuit voltage of 2.41 ±0.02 V.

The coefficients of variation of short circuit current and open circuit voltage with temperature have been determined, as mentioned before, with indoor experiment using an artificial light source. Keeping the incident irradiance at a constant value around 1000W/m², the cell is heated and the values of V_{oc} and temperature are measured. The same procedure is applied for I_{sc} . Short circuit current and open circuit voltage as temperature functions are shown in Figure 5. The experiments were implemented with temperature range for current (55 °C up to 100 °C) and for voltage (47 °C up to 75 °C).

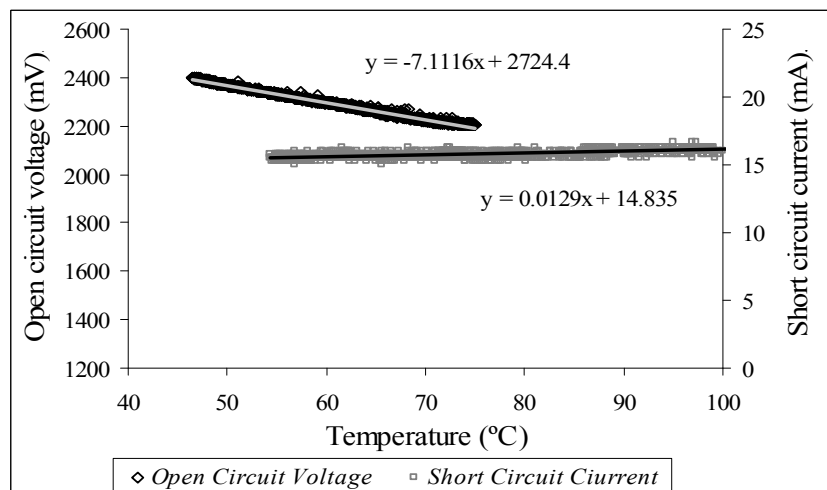

Figure 5: Short-circuit current and open circuit voltage versus temperature.

Short-circuit current under the effect of temperature shows a very small gradient, ($0.013 \pm 0.001 \text{ mA/}^\circ\text{C}$) and can be considered negligible. On open circuit voltage, temperature variation effects show a constant gradient with mean value of ($-7.11 \pm 0.03 \text{ mV/}^\circ\text{C}$).

The characteristic curve measured at one sun condition is shown in Figure 6. The power is also plotted as a function of voltage.

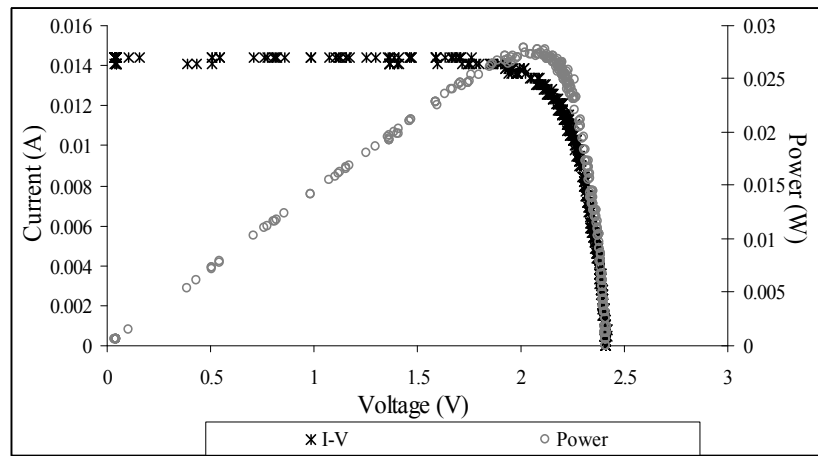

Figure 6: Characteristic curve obtained for one sun condition at 1000 W/m^2 - Standard curve

The curve shown in Figure 6 has been taken as the standard one sun curve and its short circuit current used afterwards in order to estimate the concentration rate in the tests of the cell with concentration. Values obtained for the fill factor, series resistance, effective ideality factor (for three junctions) and saturation current were 0.807, 3.82Ω , 3.16 and $6.94\text{E-}13 \text{ A}$, respectively. The maximum power obtained was 27.9 mW, resulting in an experimental efficiency of the order of 28%, rather high for one sun experiment.

Solar cell tests under concentration

Results of open circuit voltage of the cell with concentration were corrected to the same temperature (47°C), using the temperature coefficient obtained in Figure 5 ($-0.0071 \text{ V/}^\circ\text{C}$). Figure 7 shows (V_{oc}) plotted vs. $\ln(C)$.

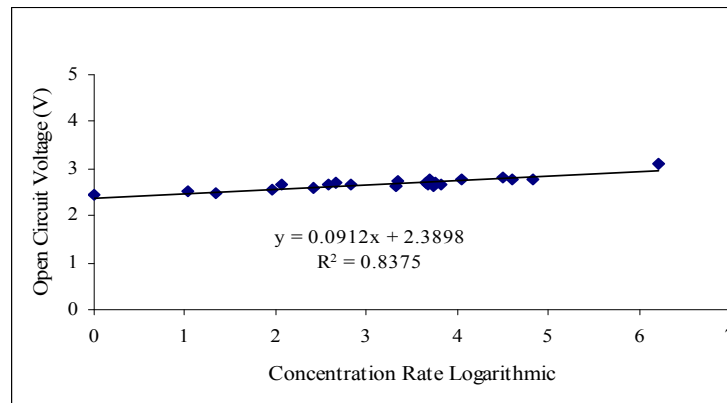

Figure 7: Open circuit voltage as a function of natural logarithmic of concentration rate

The ideality factor (m) can then be determined according to Equation 5 by dividing the slope of the curve obtained in Figure 7 by the value of the thermal voltage (v_t) for the temperature of 47°C . The value of m obtained is of the order of 3.2, corresponding to what is expected for a three junction solar cell (above 3). The ideality factor value representing an effective value for the three junctions, as Dominguez et al. (2010) employed in their treatment, and its value measured under different concentrations rate yields to, approximately, that one obtained at one sun condition (3.16).

Using the optimization method, the experimental characteristic curve for one sun can be fitted to Equation 3. With the values of I_{sc} , V_{oc} and m already known, it is found the series resistance (R_s) and saturation current (I_0) that minimizes the mean square deviation of all points of the curve. The value of (R_s) found for the curve of Figure 6 was very high, around 3.8Ω with a minimum mean square deviation in the values of current (DI) of 4.2%. Sánchez and Araújo (1984), performing an analysis of the behavior of the efficiency of the cell, as a function of concentration rate, provide a relation between the concentration rate which corresponds to the maximum efficiency (C_M) and the series resistance of the cell, assumed as a constant Equation 6.

$$C_M = mv_t / R_s I_{1sun} \quad (6)$$

where I_{1sun} is the current generated by the cell at one sun condition. From Equation 6, it can be verified that the value of R_s calculated for one sun would not allow the cell to reach high efficiency at more than two suns. This result disagrees with the expected behavior of the cell, designed to reach maximum efficiency at high concentration rates. The following results of experiments performed under concentration provide an insight into the reasons of this inconsistency.

Figure 8 shows a sample of the characteristic curves obtained experimentally under different concentration levels, but at same temperature, approximately 82 °C. Three curves are presented, the highest, for 115.6 suns, the average for 72.9 suns and the lowest for 35.6 suns.

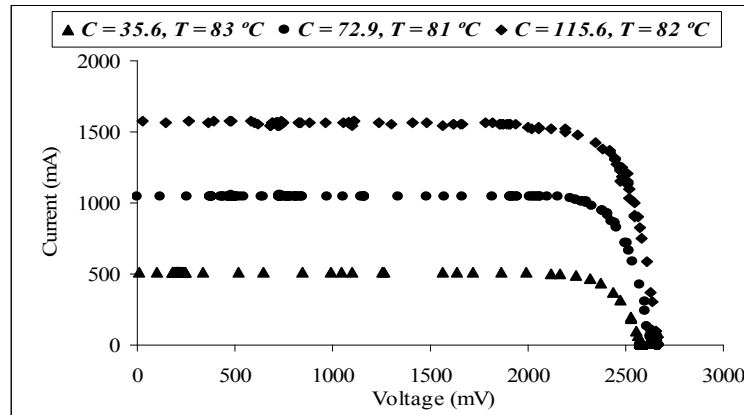

Figure 8: Characteristics curves obtained under different concentrations rates.

On this set, it can be observed just the concentration rate effect over characteristic curve increasing the short circuit current linearly and logarithmically the open circuit voltage.

Results of experiments and parameters estimative with concentration are summarized in Table 1.

C	V_{mp} (V)	I_{mp} (A)	V_{oc} (V)	I_{sc} (A)	T (°C)	DI (%)	I_0 (A)	FF
1.0	2.08	0.01	2.41	0.01	47.1	4.2	1.95E-14	0.80
2.7	2.03	0.04	2.38	0.04	72.3	2.1	5.48E-13	0.81
3.9	1.91	0.05	2.40	0.06	76.2	1.7	8.61E-13	0.78
5.9	2.10	0.08	2.44	0.08	81.9	2.0	1.24E-12	0.83
13.0	2.28	0.18	2.65	0.19	67.3	1.4	8.72E-14	0.82
14.4	2.31	0.20	2.68	0.21	60.1	3.0	4.63E-14	0.83
15.6	2.26	0.21	2.53	0.22	83.9	1.8	1.58E-12	0.84
28.6	2.35	0.40	2.78	0.41	42.8	2.0	5.78E-15	0.84
38.3	2.38	0.52	2.72	0.54	77.4	2.7	2.89E-13	0.84
40.3	2.49	0.56	2.76	0.58	56.0	2.4	3.61E-14	0.88
42.1	2.34	0.63	2.69	0.65	68.1	3.5	2.57E-13	0.84
54.2	2.26	0.75	2.61	0.78	80.4	0.8	1.72E-12	0.83
60.0	2.53	0.82	2.82	0.86	50.1	7.6	1.61E-14	0.86
63.1	2.50	0.88	2.83	0.90	49.0	1.9	1.38E-14	0.86
69.4	2.39	0.94	2.79	0.99	56.3	2.8	4.83E-14	0.82
72.7	2.30	1.01	2.64	1.05	80.9	1.5	1.9E-12	0.84
99.0	2.37	1.42	2.79	1.44	61.2	2.2	1.04E-13	0.83
107.5	2.35	1.42	2.66	1.55	80.0	1.9	2.1E-12	0.81
110.6	2.45	1.56	2.80	1.59	55.3	1.8	6.96E-14	0.86
114.9	2.27	1.56	2.66	1.65	82.1	2.6	2.6E-12	0.81
121.3	2.31	1.61	2.66	1.75	76.2	0.6	1.77E-12	0.80
122.3	2.49	1.55	2.75	1.75	67.1	4.4	3.19E-13	0.80

Table 1: Characteristic parameters according to concentration rate.

The fill factors shown in Table 1 were obtained from the values of V_{oc} , I_{sc} , V_{mp} and I_{mp} . The root mean square deviations (DI) were calculated between the values of current, measured and estimated with one diode model for all points in each curve.

Although the temperature of the cell during experiments presents large variations (20% deviation, average temperature of 67° C), it can be observed some important characteristics of the MJ cell when concentration rate varies. The open circuit voltage increases rapidly for low concentrations, reducing its increase rate for high values of C (logarithmic behavior). For the whole range of concentration, high and relatively uniform values of fill factor are observed (above 0.8). The average value is around

0.83 ± 0.02 . The saturation diode current presents high dispersion in the range of (C) shown in Table 1. The average value for all concentrations is around 7.1×10^{-13} A.

Values obtained for R_s extracted from the characteristic curves present a strong decrease when concentration varies from one ($R_s=3.8 \Omega$) up to thirty ($R_s = 0.029 \Omega$). For concentrations greater than thirty times, the average series resistance is around $0.024 \pm 0.008 \Omega$. The average root mean square deviation observed for all the curves is around 2.05%. The behavior of series resistance as a function of concentration rate for three measured results and corrected values for 47 °C and 25 °C are plotted in Figure 9.

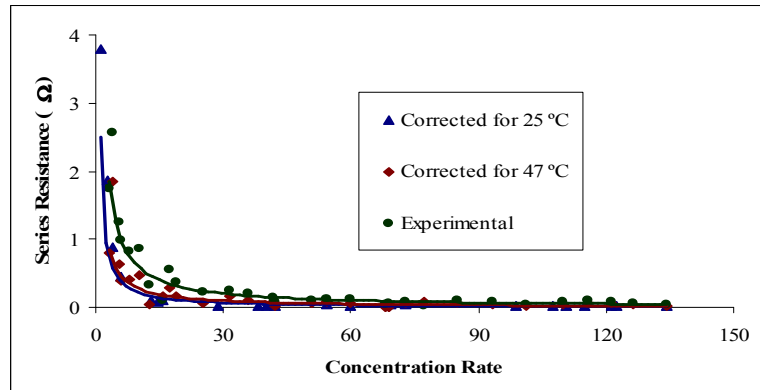

Figure 9: Series resistance vs. Concentration Rate.

The trend shown on these curves can be explained by concentration rate effects composition over current and voltage simultaneously. As effects concentration ratio e are predominant over the current (linear dependence) compared with ones over voltage (logarithmic dependence), it can be said about the trend established series resistance assumed inversely proportional to concentration rate. The value obtained for the average series resistance at high concentration rates ($C > 30$) ($R_s = 0.024 \pm 0.008 \Omega$) agrees with information found in literature. A detailed evaluation of series resistance (R_s) of a cell with similar characteristics was performed by Nishioka (2006). Considering contributions of ohmic contacts, tunneling junctions and electrodes resistance the R_s found was in the order of 0.025Ω . A smaller R_s value was found by Dominguez (2010), on order of 0.017Ω .

Maximum conversion efficiency presented by cell during operation was determined by maximum generated power and incident power (incident irradiance multiplied by cell the area). Figure 10 presents experimental efficiency as a function of concentration rate. Also, values of efficiency translated to the temperature of the one sun curve are represented. As mentioned, the IV curve in (Figure 6), corrected for the usual reference temperature in photovoltaics (25 °C), is taken as a reference curve.

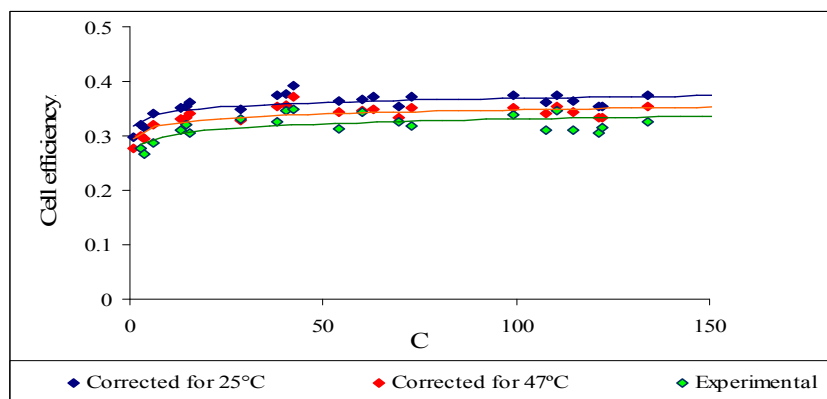

Figure 10: Efficiency vs. Concentration Rate.

It is observed in Figure 10 an increase of efficiency for very low values of concentration. The lowest efficiency was 27% for ($C=4$) and cell temperature of (71°C). For concentrations greater than 30, the efficiency increases slowly, almost stabilizing, with an average value of 0.33 ± 0.02 . It is expected that for some high value of concentration the efficiency will start to fall down. This behavior can not be observed in the restricted range of C used in the experiments. The average values of efficiencies corrected for temperatures of 47°C and 25°C, obtained for concentration rate greater than 30 are respectively $0.35 \pm 0.01 \%$ and $0.37 \pm 0.01 \%$.

Small values of series resistance obtained for high levels of concentration rate ($C > 30$) allow reaching high efficiency at this region. Using the average R_s of 0.024Ω we estimate the concentration ratio which provides the maximum efficiency for the three cases: experimental, cell temperature translated to 47°C and to 25°C (Eq.6). Results obtained are 278, 261 and 243, much higher than that obtained from the one sun experiment ($R_s = 3.8$, $T = 47^\circ\text{C}$ and concentration for maximum efficiency $C = 1.6$).

CONCLUSIONS

The procedure adopted to obtain characteristic parameters, based on the one diode model, of 1.0 cm² MJ cell, operating under real conditions and subject to concentration ratios varying between one and almost one hundred and fifty, yields a consistent general picture of solar cell behavior in spite of large temperature and irradiance experimental variations, during the analysis of the cell under natural and random conditions performed.

A large series resistance (3.8 Ω) is observed for low concentration values. This resistance is rapidly decaying, attaining a stable value two orders of magnitudes lower (0.029Ω) at a concentration ratio of 30. For concentrations rate above 30, average conversion efficiencies of 35% have been measured when converted to temperatures of 47°C. Series resistance obtained for high concentrations (0.024Ω) limit the concentration ratio corresponding to maximum efficiency to values between 243 and 278. Higher concentration ratios and probably higher efficiencies require further reduction of series resistance.

The high dispersion observed in the saturation diode current extracted from experimental characteristic curves requires performing further analysis of this parameter. Correction of the parameters that determine the saturation current at their respective temperature gradients probably will reduce the dispersion of its measure.

REFERENCES

- Daliento S. and Lancellotti, L. (2010). 3D Analysis of the performances degradation caused by series resistance in concentrator solar cells, *Solar Energy* 84, 44–50.
- Dominguez, C. *et al.* (2010). Multijunction solar cell model for translating I–V characteristics as a function of irradiance, spectrum, and cell temperature. *Progress in Photovoltaics*, 18, 272-284.
- Emery, K. (2003). Measurement and characterization of solar cells and modules. In: LUQUE, A. and HEGEDUS, S. *Handbook of photovoltaic science and engineering*. John Wiley & Sons Ltd, England.
- Garcia, M. C. A. Modelado de componentes de sistemas fotovoltaicos autónomos. In: *Fundamentos, dimensionado y aplicaciones de la energía solar fotovoltaica* (1995), Madrid, CIEMAT.
- Grenn, M. A. (1982). *Solar cells*. London: Prentice-Hall International.
- Grenn, M. A. *et al.* (2011). Solar cell efficiency tables (Version 38). *Progress in Photovoltaics: Research and Applications* 19, 565-572.
- Guter, W. *et al.* (2009). Current-matched triple-junction solar cell reaching 41.1% conversion efficiency under concentrated sunlight. *Applied Physics Letters*, 94, 223504.
- KATZ, E. A. *et al.* (2006). Photovoltaic characterization of concentrator solar cells by localized irradiation, *Journal of Applied Physics*, 100, 044514, 1-8.
- King, R. R. *et al.* (2005). Pathway to 40% efficient concentrator photovoltaics. In *Proceedings of the 20th European Photovoltaic Solar Energy Conference*, Barcelona, Spain, 118–123.
- King, R.R. *et al.* (2007). 40% efficient metamorphic GaInP/GaInAs/Ge multijunction solar cells. *Applied Physics Letter* 90, 183516.
- Nishioka, K. *et al.* (2006). Evaluation of InGaP/InGaAs/Ge triple-junction solar cell and optimization of solar cell's structure focusing on series resistance for high-efficiency concentrator photovoltaic systems. *Solar Energy Materials & Solar Cells*, 90,1308-1321.
- NREL, National Renewable Energy Laboratory. Available in: [http:// www.nrel.gov/](http://www.nrel.gov/). Accessed in: Jan. (2011).
- Ortiz-Conde, A. *et al.* (2006). New method to extract the model parameters of solar cells from the explicit analytic solutions of their illuminated I–V characteristics, *Solar Energy Materials & Solar Cells* 90, 352–361.
- Sánchez E. and Araújo G. L. (1984). Mathematical analysis of the efficiency-concentration characteristic of a solar cell. *Solar Cells*,12, 263 - 276.
- Tanabe, K. (2009). A Review of Ultrahigh Efficiency III-V Semiconductor Compound Solar Cells: Multijunction Tandem, Lower Dimensional, Photonic Up/Down Conversion and Plasmonic Nanometallic Structures. *Energies*. 2, 504-530.

ABSTRACT: The performance of a CPV multijunction (MJ) cell of 1.0 cm² was evaluated for various concentration ratios. Parameters which characterize the cell were extracted from experimental characteristic curves using the one diode model. Special attention was given to series resistance which effects can change significantly the cell performance. Results obtained show that the procedure adopted is considerably consistent, enabling to obtain a general picture of solar cell behavior in spite of large temperature and irradiance experimental variations. A large series resistance (3.8 Ω) is observed for low concentration values. This resistance decays rapidly, attaining a stable value for high concentrations (0.024 Ω). Average conversion efficiency of 35% have been measured when converted to temperatures of 47 °C. Series resistance obtained for high concentrations limits concentration ratio corresponding to maximum efficiency to values between 243 and 278. Higher concentration ratios and probably higher efficiencies require further reduction of series resistance.

Key words: MJ cell, characteristic curves, series resistance, conversion efficiency.